



*For trust, we deliver*

上海必趣医疗科技有限公司

BQ PLUS MEDICAL CO.,LTD.

Add: No18, Cheye Road, Chedun Town, Songjiang

Shanghai 201611 CHINA

Tel: +86-21-5760 9106

Mailbox: info@bq-medical.com

Website: www.bqplusmedical.com

www.bq-medical.com

www.bq-eo.com



BQ Plus Medical is certified by TUV  
Rheinland LGA Products GmbH  
for ISO 13485: 2016,  
ISO 11135: 2014, and MDD 93/42/EEC.  
FDA registration No:3013023255

上海必趣医疗科技有限公司  
BQ PLUS MEDICAL CO.,LTD.

www.bqplusmedical.com  
www.bq-medical.com  
www.bq-eo.com



# A safe closed system 安全的封闭系统

- TPU+PVC co-extrusion
- Two layers makes sure DEHP-free to solution
- Light-resistance to ensure the effect of light-ser
- Complete closed system



- Thickness of TPU  $\geq 0.12\text{mm}$ .
- Decolorization is qualified.
- Light-resistance is qualified (290nm~450nm wavelength).

- Extrusion chamber can be 90mm length.
- 15um nylon filter at the bottom guarantees the flow and particle filtration.
- 8um liquid lock filter is available.

### Needle Free Valve

- MRI compatibility
- Blood compatibility
- Smooth and tight seal, easy to disinfect thoroughly
- No leakage under 200kpa
- Good self-resilience enables the safe administration of medication.

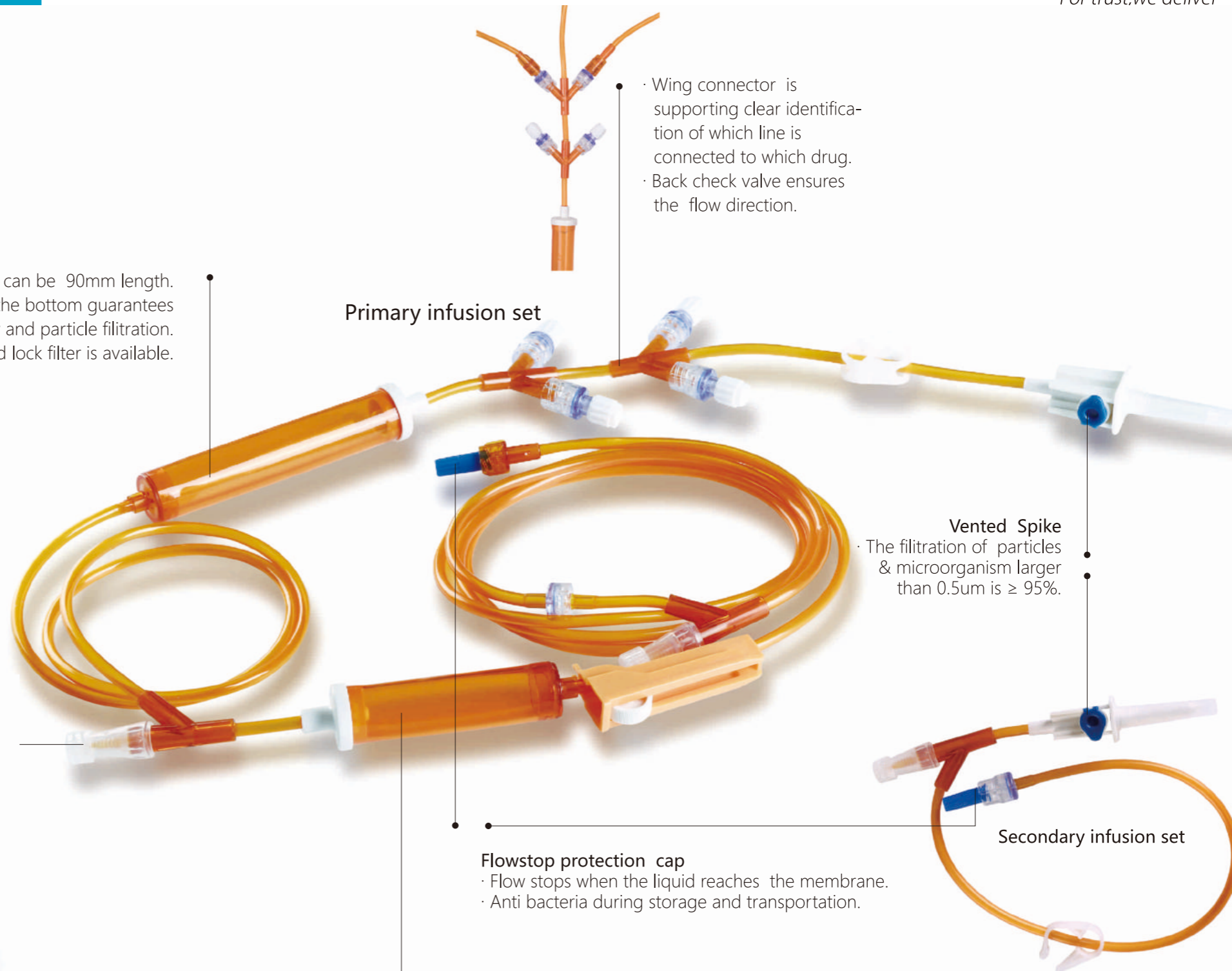

- One more chamber to collect the air created during the administration.

Do not disconnect the wing connect during and after the infusion in order to maintain the closed system. 







### Handling Step

- 1 Close venting cap.
- 2 Spike the container.
- 3 Squeeze the drip chamber to fill the drip chamber by 1/2 volume.
- 4 Prime the primary set completely.

### Safety Feature

- Air vent filter in spike helps to avoid contamination during venting.
- Easy and convenient spiking while helping reduce risks of sharp injury.
- Fluid filter in the chamber to avoid particular contamination.
- Hydrophobic, bacteria retentive cap maintaining a closed system until connect to primary infusion set without spillages of fluid.



### Handling Step

- 1 Close the robert clamp on the primary set.
- 2 Connect secondary set to primary set and start treatment.

### Safety Feature

- Closed robert clamp prevents a contamination of flushing solution to reduce the risk of drug contamination.



### Handling Step

- 1 Close venting cap.
- 2 Spike the container.
- 3 Prime the secondary infusion set.

### Safety Feature

- Air vent filter in spike helps to avoid contamination during venting.
- Easy and convenient spiking while helping reduce risks of sharp injury.
- Back check valve ensures fluid direction.
- Hydrophobic, bacteria retentive cap maintaining a closed system until connect to primary infusion set without spillages of fluid.



### Handling Step

- 1 Close the robert clamp.
- 2 Connect prepared syringe with diluted drug to the needle free valve.
- 3 Inject drug into container and mix the drug well.

### Safety Feature

- Helps to avoid chemical contamination.
- No direct contact to the needle free valve reduce risk of microbiological contamination.
- No needle-stick injury.



### Handling Step

- 1 After each drug flush the line completely with flushing solution.
- 2 Open robert clamp to start the next treatment.

### Safety Feature

- Wing connector is supporting clear identification of which line is connected to which drug.
- Back check valve ensures the flow direction.



### Handling Step

- 1 Dispose as a closed system.

### Safety Feature

- Due to no disconnection is necessary, it helps a lot to avoid the risk of chemical contamination.

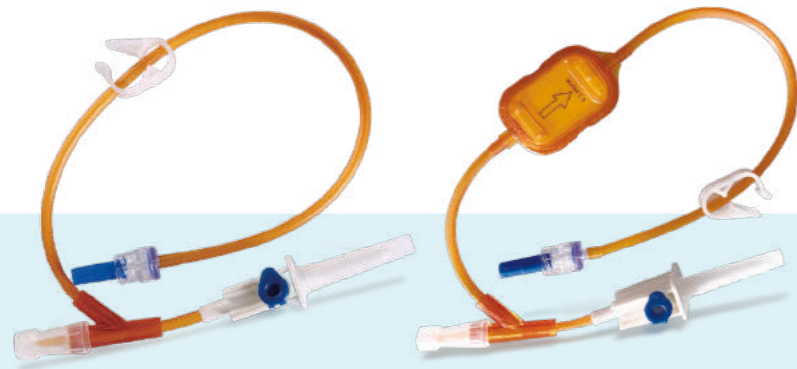

**Secondary infusion set**

- Vented spike
- Needle free valve\*1pc
- Precision filter 0.22/1.2/5um(optional)
- Robert clamp
- Back check valve\*1pc
- Prime stop cap

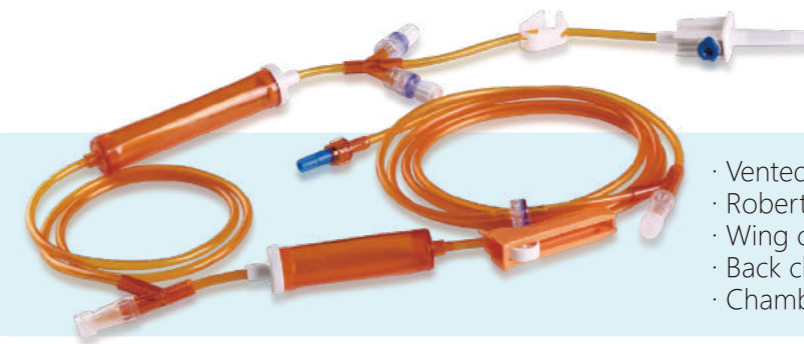

**Primary infusion set with two Y-ports & three BCV**

- Vented spike
- Robert clamp
- Wing connector\*1pc
- Back check valve\*3pcs
- Chamber-62mm
- Chamber-90mm
- Needle free valve\*2pcs
- Roller clamp
- Male luer lock
- Prime stop cap

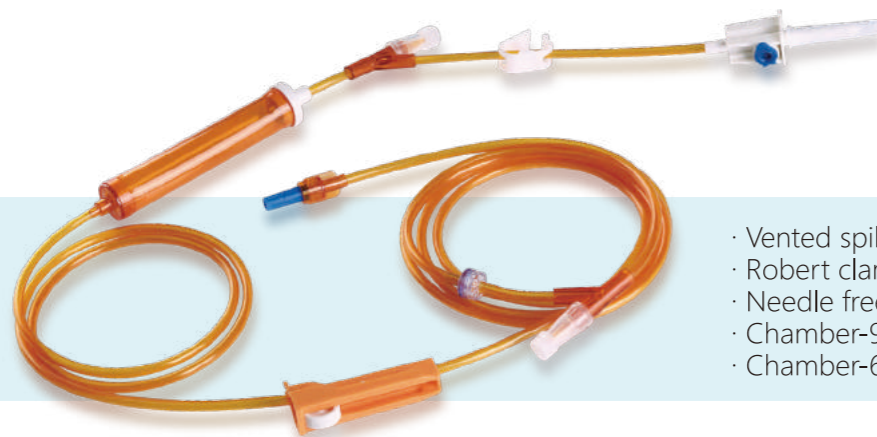
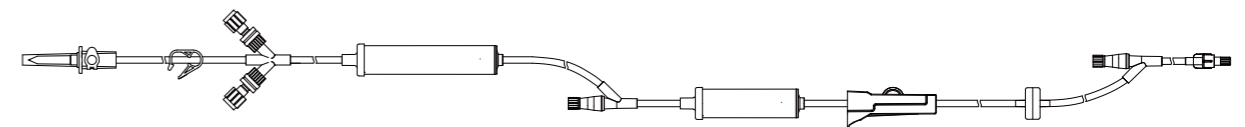

**Primary infusion set with two Y-ports**

- Vented spike
- Robert clamp
- Needle free valve\*2pcs
- Chamber-90mm
- Chamber-62mm
- Roller clamp
- Back check valve
- Male luer lock
- Prime stop cap

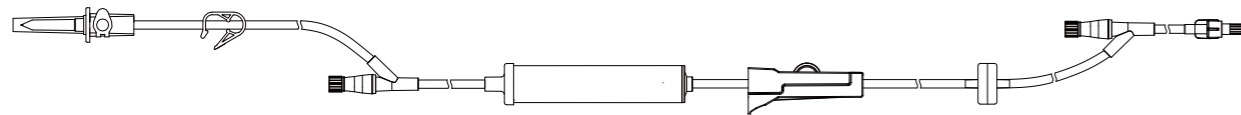

**Primary infusion set with two Y-ports & five BCV**

- Vented spike
- Robert clamp
- Wing connector\*2pc
- Back check valve\*5pcs
- Chamber-90mm
- Chamber-62mm
- Needle free valve\*2pcs
- Roller clamp
- Male luer lock
- Prime stop cap

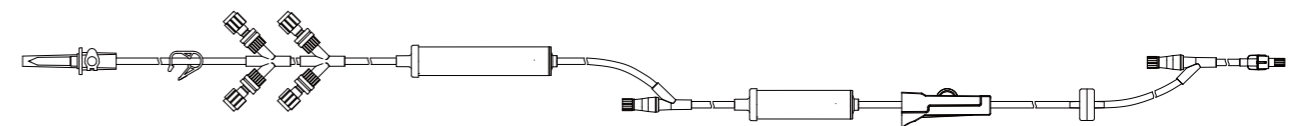



# Safety ENFit Enteral Nutrition Feeding Set

## 喂食系列

### Enteral Feeding Bags & Enteral Feeding Sets 喂食系列



#### Enteral Feeding Bags

喂食袋套装

- ① Feeding bag(Gravity/Pump, 500/1000/1200ml)
- ② PVC tubing (DEHP/Non-DEHP)
- ③ Roller clamp
- ④ IV chamber
- ⑤ Silicon tubing(Optional)
- ⑥ Silicon connector(Optional)
- ⑦ Feeding Y connector with cap
- ⑧ Enfit lock female luer with cap
- ⑨ Caution tag
- ⑩ Patient label

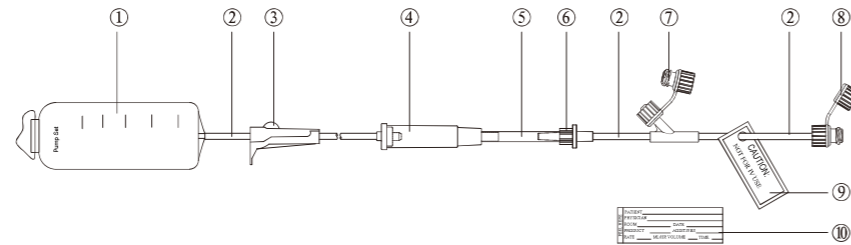

#### Enteral Feeding Sets

喂食管套装

- ① Spike with cap
- ② PVC tubing (DEHP/Non-DEHP)
- ③ Roller clamp
- ④ IV chamber
- ⑤ Silicon tubing(Optional)
- ⑥ Silicon connector(Optional)
- ⑦ Feeding Y connector with cap
- ⑧ Enfit lock female luer with cap
- ⑨ Caution tag
- ⑩ Patient label

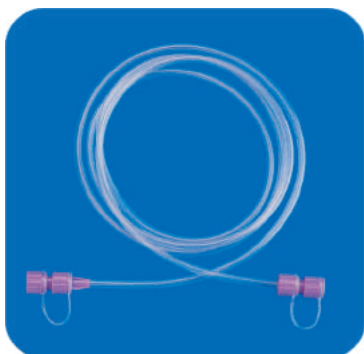
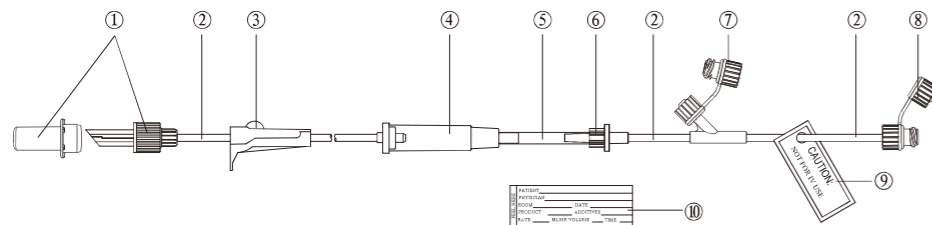

#### ENFit Extension Sets

喂食延长管

- ① Enfit lock female luer with cap
- ② PVC tubing (DEHP/Non-DEHP)
- ③ Enfit lock male luer with cap
- ④ Tubing OD 3.0/4.0mm

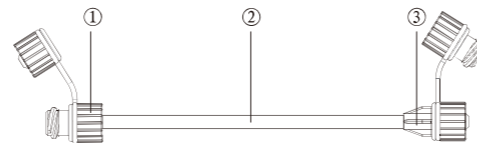

# Safety ENFit Syringes & ENFit Components

## 喂食注射器&喂食配件

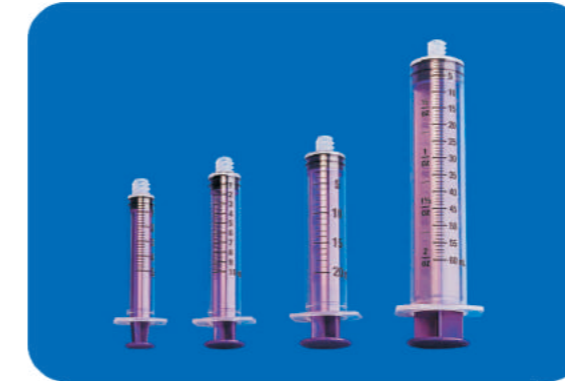

#### ENFit Syringes

喂食注射器

Volume	Graduation	Applications	Optional Package
1ml, 3ml, 5ml, 10ml	0.2ml	Medicine, Flush	Blister Pack
20ml, 35ml, 60ml	1.0ml	Hydrate, bolus feed	Back Pack

#### ENFit Components 喂食配件



#### EN-CP02

Spike with protector



#### EN-YS01

Y-connector with cap

- Y-connector EN-ST115Y
- Adapter ring ENS01
- Female cap EN-HT132



#### EN-CN07

Adaptor for syringe



#### RC101-B

Roller clamp



#### EN-MH01

ENFit lock male connector with cap

- Male Adapter EN-MLL15
- Adapter ring ENS01
- Female cap EN-HT132
- For tubing OD 3.0/4.0mm



#### EN-FH01

ENFit lock female connector with cap

- Female Connector EN-FLL05
- Adapter ring ENS01
- Male cap EN-HT133
- For tubing OD 3.0/4.0mm



#### EN-CP05

ENFit transition connector



#### EN-CP04

Christmas tree connector

## 成品输液套装--泵用型

### Pump IV Set

泵用型输液器

Acute care, Long term care, Home care, emergency responders, veterinarians, etc, all use drug delivery pumps to provide accurate infusion rates.

The most common drug delivery pumps use linear peristaltic motion. Silicone tubing and common PVC tubing sets are used for peristaltic pump. PVC tubing sets are more economic as consumables.

The CDC guidelines in USA are now requests 96 hours duration for pump IV sets.

But the Fatigue Resistance of PVC tubing in market could not meet long time usage requirement. Typical IV sets can only last for a few hours.

BQ+ has been licensed with **NF96 Pump Tubing** technology, which allows tubing keep running **96 hours** without fatigue. This DEHP Free tubing is made from patented compound formula with unique production process.

Since BQ+ is a professional IV components manufacturer, BQ+ has big range of various IV components. With all kinds of self-made components and also NF96 pump tubing, you could rely on BQ+ to **customize your pump sets**.

To customize your IV pump set, all you need to do is:

1. Please provide one of your pumps (we will return the pump after testing)
2. Provide one case of the tubing you use today (for benchmarking)
3. We will then do performance testing and design a NF96 tubing for your application.
4. After you approved the tubing, we could provide complete set samples for you.

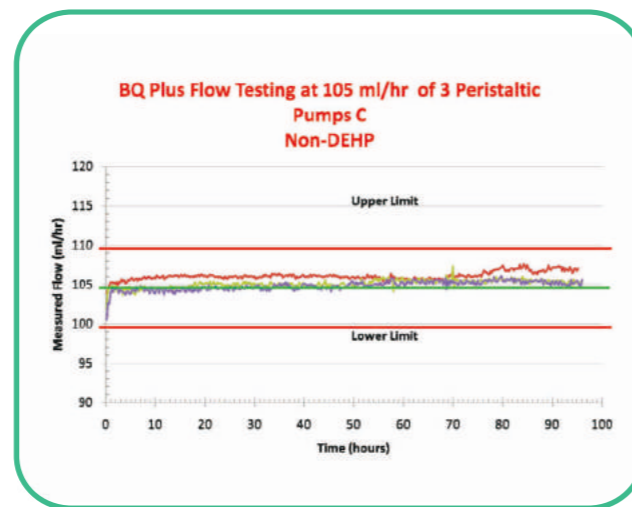

## 成品输液套装--泵用型

### BQ+ Lines IV Set for Volumetric Pumps



#### IV Set

- Standard IV set for infusion of drugs and liquids
- Drop chamber, 20 drops/ml, filter 15µm
- Roller clamp
- Y-port injection site, latex free
- Slide clamp
- Male luer lock
- Pump tubing length: 30/180 cm

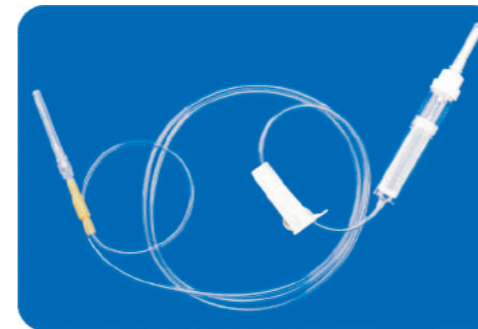

#### Transfusion Set

- Standard IV set for transfusion of blood or blood similar liquids
- Drop chamber, 20 drops/ml, filter 200 µm
- Roller clamp
- Flashback
- Male luer lock
- Hypodermic Needle
- Pump tubing length: 150/180 cm

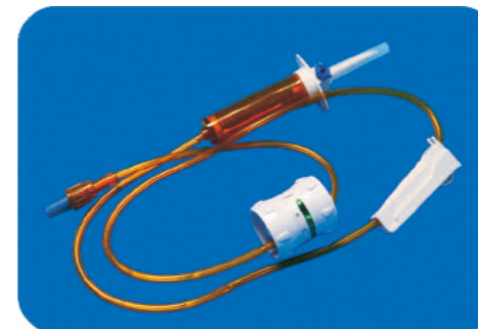

#### Light Resistant IV Set

- Standard IV set for light sensitive drugs
- Drop chamber, 20 drops/ml, filter 15 µm
- Roller clamp
- Flashback
- Male luer lock
- Pump tubing length: 150/180 cm

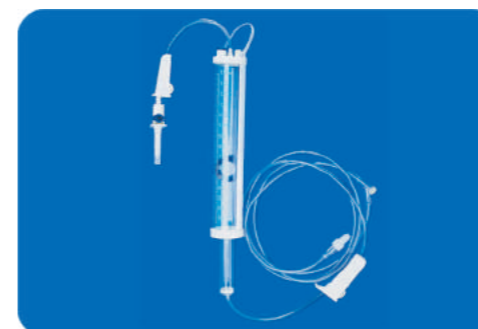

#### IV Burette Set

- Standard IV set for Burette set
- Vented spike
- Roller clamp
- 100ml/150ml Burette chamber (Optional)
- Y-port injection site, latex free
- Male luer lock
- Pump tubing length: 30/180 cm





## 成品输液器套装--止液型

**Liquid Lock**

- Prevent air infusion
- Higher filtration
- Efficiency of 8µm

Hydrophilic PES Membrane

**Roller Clamp**

- Average adjustment range: 19mm
- Hold the tube end
- Protect from sharp spike

**Vented air cap**

- Hydrophobic membrane 0.5µm

**Drip chamber**

- 20 drops/ml
- Φ16.3\*72mm
- PVC/TPE

**Prime Stop Cap**

- Air pass
- No drops

**Tubing**

- DEHP free
- PVC free

**A7F**

64空气塞无滤网滴瓶头部, 20滴  
64mm, Vented assembled chamber, 20drop/ml

- Spike protector, 40mm, PE
- Spike, 20 drop/ml, ABS
- Vented air cap VAC02, PVC, Hydrophobic membrane 0.5µm
- Chamber, Φ15.5x64mm, PVC
- Liquid lock membrane, 8µm

**N7F**

64无滤网滴瓶头部, 20滴  
64mm, Non-vented assembled chamber, 20 drop/ml

- Spike protector, 40mm, PE
- Spike, 20 drop/ml, ABS
- Chamber, Φ15.5 x 64mm, PVC.
- Liquid lock membrane, 8µm

## 成品输液器套装--止液型

### We Can Customize Liquid Lock IV Sets For You



#### Gravity IV Set

- Standard IV set for infusion of drugs and liquids
- Liquid lock drop chamber, 20 drops/ml, filter 8µm
  - Roller clamp
  - Needle free Y injection site
  - Male luer lock



#### Pump IV Set

- Pump IV set for infusion of drugs and liquids
- Liquid lock drop chamber, 20 drops/ml, filter 8µm
  - Roller clamp
  - Y-port injection site, latex-free
  - Slide clamp
  - Male luer lock



#### PVC Free IV Set

- IV set for infusion of drugs and liquids
- Liquid lock drop chamber, 20 drops/ml, filter 8µm
  - Roller clamp
  - Y-port injection site, latex-free
  - Male luer lock
  - PVC free

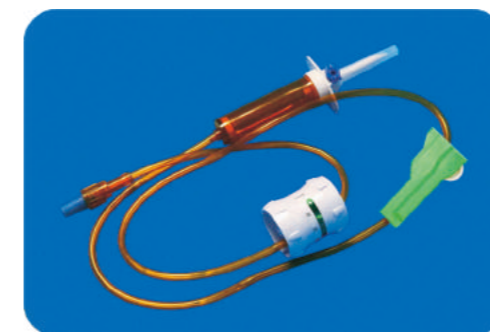

#### Light Resistant IV Set

- Light Resistant IV set for infusion of drugs and liquids
- Liquid lock drop chamber, 20 drops/ml, filter 8µm
  - Roller clamp
  - Flashback
  - Male luer lock

DEHP Free  
PVC Free

## 成品输液套装--不含PVC



### IV Administration Set, TPE material

TPE输液器

**Strong features:**

IV Set/Features	DEHP	Drug absorption	Lead, chromium and other metal ions	Burning can produce carcinogens
PVC	Contain	Absorption of some drugs	Contain	Yes
TPE	No	No	No	No

**Comparison of the drug absorption value of TPE infusion set with PVC infusion set :**

Drug	PVC	TPE
Nitroglycerin injection	41.10%	0
Nimodipine Injection	18.50%	0
C Mostyn injection	10.10%	0
Diazepam Injection	34.60%	0

**Comparison between TPE infusion set and PVC infusion set:**

Item	PVC	TPE
Readily oxidizable substance (ml)	≤2.0	≤0.1
Metal ion (µg/ml)	Total content of barium, chromium, copper, lead, tin no more than 1	No
	Content of cadmium no more than 0.1	No
PH value	≤1	≤0.01
UV absorbance	≤0.1	≤0.01
Evaporation residue (mg)	≤5	≤0.4
Hemolysis rate	≤5%	≤1%
Cell toxicity	≤Class 1	No
Skin sensitization	≤Class 1	No
Intracutaneous stimulation	≤1	No

**Intended for:**

- (1) Replace the traditional PVC infusion device for all types of patients with venous infusion.
- (2) The newborn, infant, child or the elderly care, the sensitivity and etc.
- (3) The male preadolescence, the woman in pregnant or lactation.
- (4) Severe patients, postoperative patients, patients with blood diseases, long-term infusion patients and etc.

**Applicable drugs:**

All drugs for intravenous infusion.

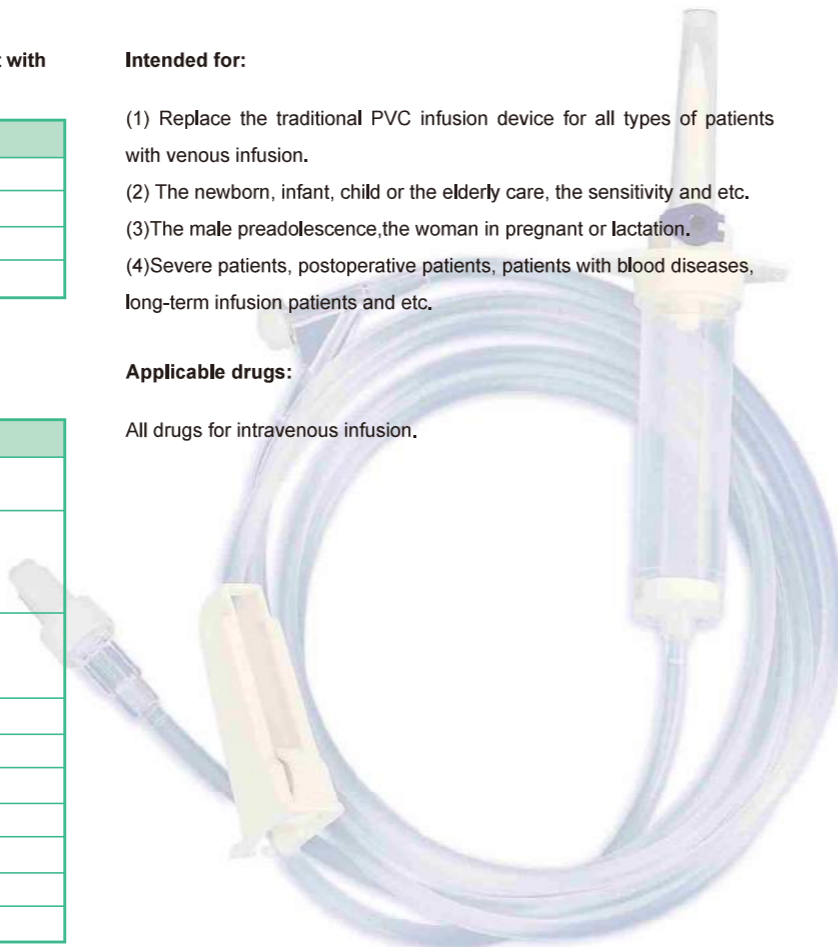

## 成品输液套装--不含PVC

**New Trends : Hospitals Demand Switch to PVC-Free Devices, say TPE. BQ Plus supplies you the following standard TPE Sets:**



### IV Set

- Standard IV set for infusion of drugs and liquids
- Drop chamber, 20 drops/ml, filter 15µm
  - Roller clamp
  - Y-port injection site, latex free
  - Slide clamp
  - Male luer lock

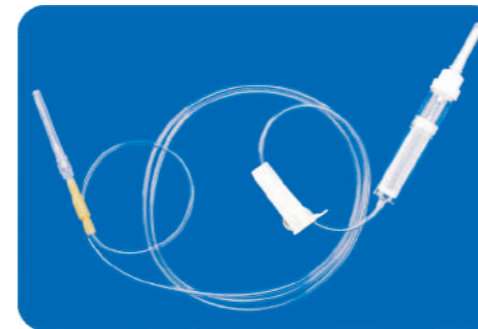

### Transfusion Set

- Standard IV set for transfusion of blood or blood similar liquids
- Drop chamber, 20 drops/ml, filter 200 µm
  - Roller clamp
  - Flashback
  - Male luer lock
  - Hypodermic Needle

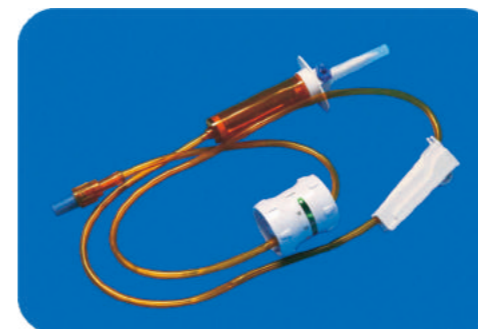

### Light Resistant IV Set

- IV set for light sensitive drugs
- Drop chamber, 20drops/ml, filter 15um
  - Roller clamp
  - Flow regulator
  - Male luer lock



### IV Burette Set

- Standard IV set for Burette set
- Vented spike
  - Roller clamp
  - 100ml/150ml Burette chamber (Optional)
  - Y-port injection site, latex free
  - Male luer lock



## 三通阀



**Features:**

- 1.Handle is stopped every 45 degrees angle  
手柄45° 转角停顿
- 2.Luer lock rotates 360° to prevent tubing kinking  
鲁尔螺旋管360° 无缠绕, 防止折管

Item	Color	Technical Data			Certificates
		Pressure resistance	Flow rate	Material	
SK45-R	Red	200KPa	Flow rate > 1000ml/10mins	PC& PE& POM& PP	CE certified
SK45-Y	Yellow				
SK45-B	Blue				



SK45-R

SK45-Y

SK45-B



SK46



SK47

## 成品输液套装—带三通阀

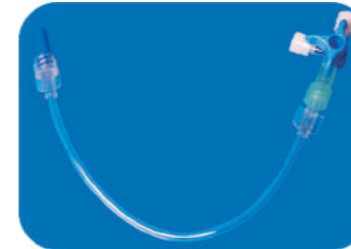

### Extension Set

- Extension set for infusion and transfusion.
- Male luer lock
  - Female luer lock
  - 3 way stopcock
  - Tubing Length: 15/30/60/90/120cm



### Gravity IV Set

- Standard IV set for infusion of drugs and liquids
- Drop chamber, 20 drops/ml, filter 15um
  - Roller clamp
  - Male luer lock
  - 3 way stopcock
  - Male luer lock



### Pump IV Set

- Pump IV set for infusion of drugs and liquids
- Drop chamber, 20 drops/ml, filter 15um
  - Roller clamp
  - Male luer lock
  - 3 way stopcock
  - Needle free valve
  - Male luer lock



### IV Burette Set

- Standard IV set for Burette set
- Vented spike
  - Roller clamp
  - 100/150ml Burette chamber(optional)
  - Roller clamp
  - Male luer lock
  - 3 way stopcock
  - Needle free valve
  - Male luer lock



# BQ+Needle Free Valve

## 无针加药件

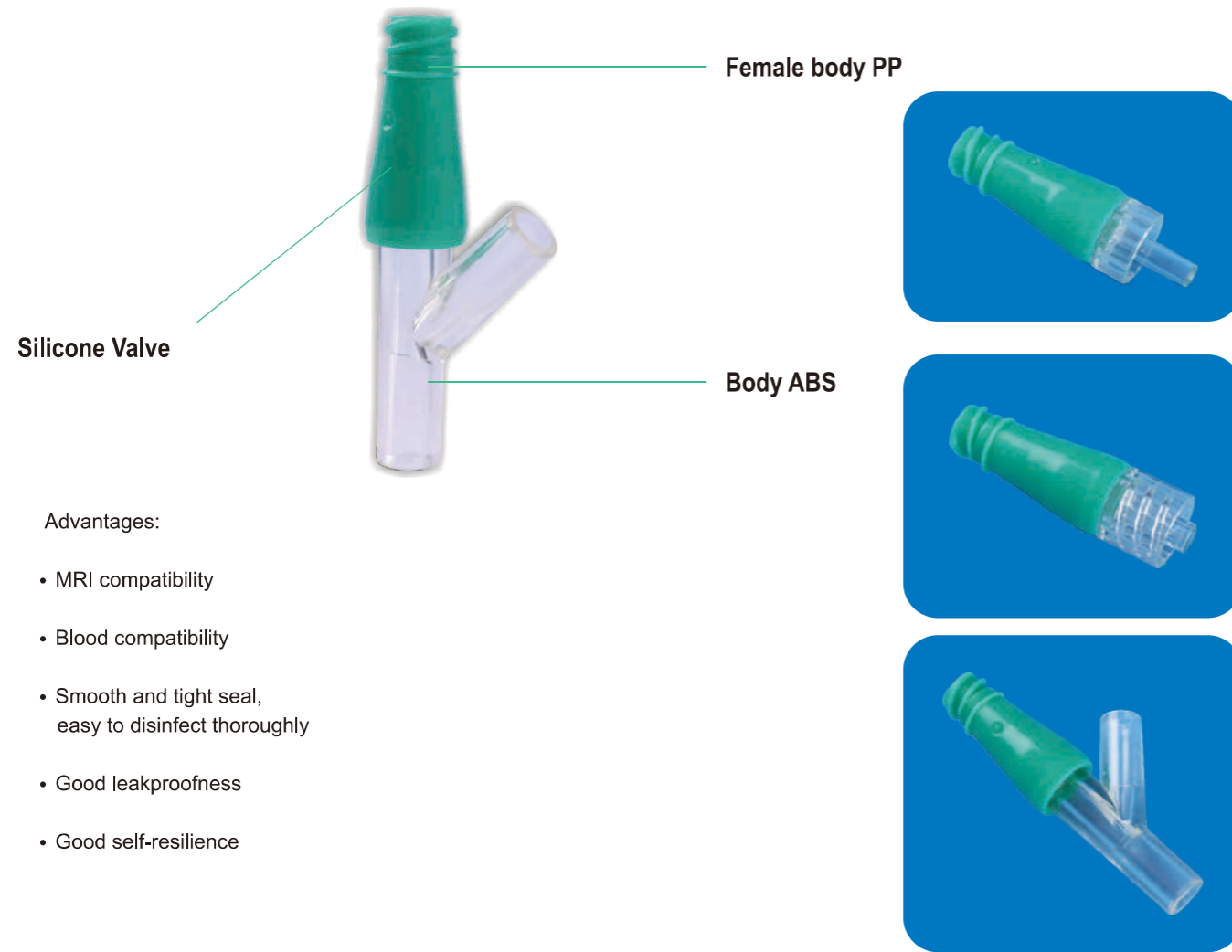

Advantages:

- MRI compatibility
- Blood compatibility
- Smooth and tight seal, easy to disinfect thoroughly
- Good leakproofness
- Good self-resilience

Item	Functional Activation	Priming Volume	Flow Rate	Leakproofness	Material	Dimension(mm)	Weight(g)
NFV-L16	Over 200 times	0.06ml	2000ml/min	No leakage under 200kpa by air pressure & hydraulic pressure	PP, ABS and Silicone	35*11*11	1.7
NFV-S16		0.09ml	850ml/min			37*11*11	1.7
NFV-Y16		0.47ml	850ml/min			48*11*11	2.3

# Finished IV Set with Needle Free Valve

## 成品输液套装--带无针加药件



### Needle Free Valve

Blister Package  
OEM available

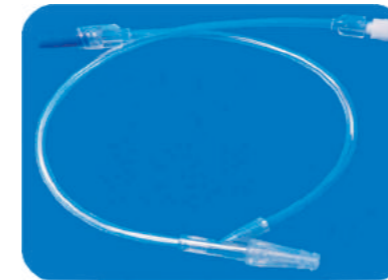

### Extension Set

Extension set for infusion and tranfusion  
·Female luer lock  
·Needle free valve  
·Male luer lock  
·Tubing Length: 15/30/60/90/120cm



### Gravity IV Set

Standard IV set for infusion of drugs and liquids  
·Drop chamber, 20 drops/ml, filter 15um  
·Roller clamp  
·Needle free valve  
·Male luer lock



### IV Burette Set

IV set for Burette set  
·Vented spike  
·Roller clamp  
·100/150ml Burette chamber(optional)  
·Roller clamp  
·Flow regulator  
·Needle free valve  
·Male luer lock

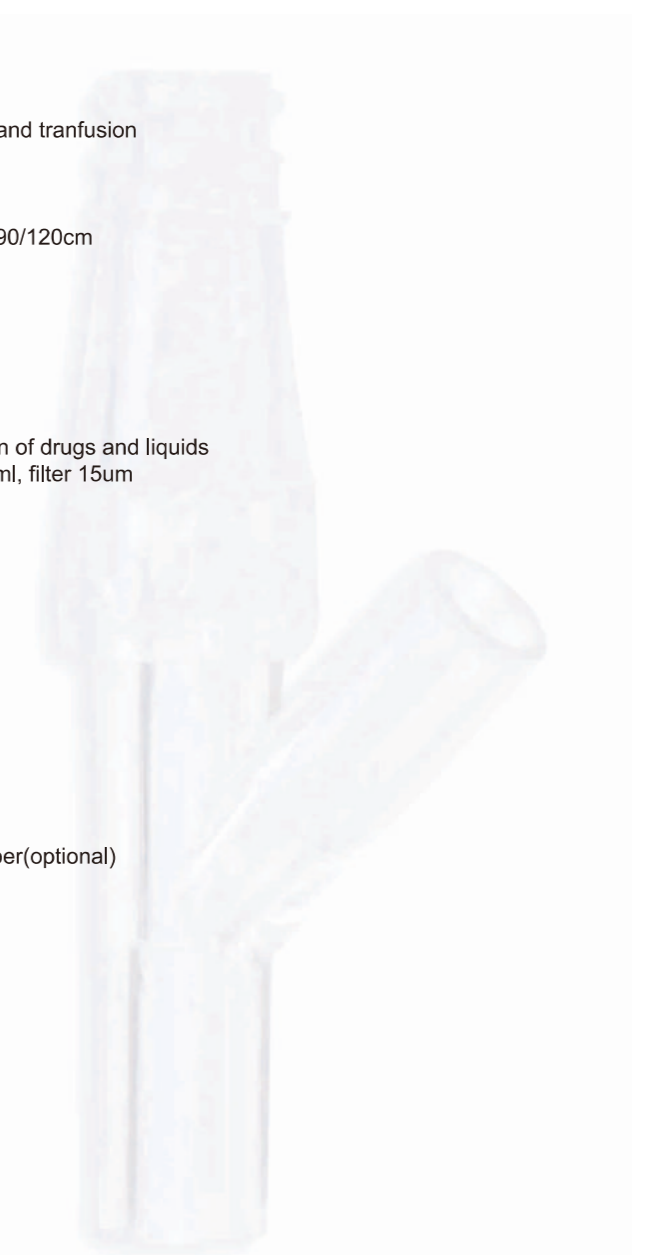



# BQ+ Flow regulator

## 微量调节器



### Features:

1. Precision flow control

精准的流量控制

2. Flow rate tolerance

示值误差

20ml -10%~50%

> 20ml ±20%

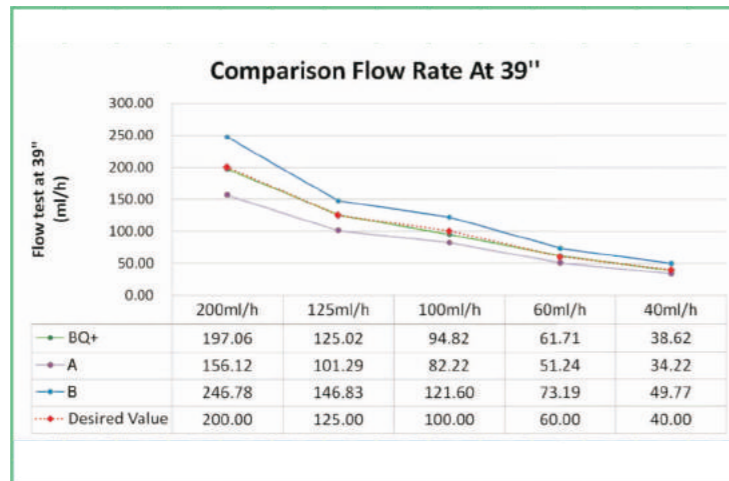

- Test by: BQ Plus Medical
- Test date: 2016.2.1~2.2
- Head height: 39"

Item	Technical data					
	Fitting for	Dimension Diameter*Height (mm)	Operating range	Max Operating Pressure	Max Operating temperature	Material
FR-6 Single Scale	3.0*4.1mm tubing	31*36	20-250ml	0.5 bar in static condition, gravity set	40 C	ABS&TPE
FR-7 Double Scale						

# Finished IV Set with Flow Regulator

## 成品输液套装—带流量调节器

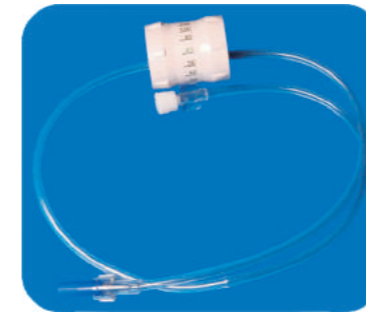

### Extension Set

Extension set for infusion and transfusion.

- Female luer lock
- Flow regulator
- Male Luer lock
- Tubing Length: 15/30/60/90/120cm



### Gravity IV Set

Standard IV set for infusion of drugs and liquids

- Drop chamber, 20 drops/ml, filter 15um
- Roller clamp
- Flow regulator
- Male luer lock

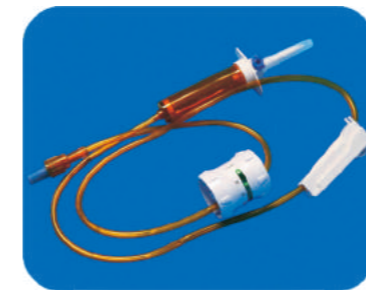

### Light Resistant IV Set

Standard IV set for light sensitive drugs

- Drop chamber, 20 drops/ml, filter 15um
- Roller clamp
- Flow regulator
- Rotating Male luer lock



### IV Burette Set

Standard IV set for Burette set

- Vented spike
- Roller clamp
- 100/150ml Burette chamber(optional)
- Roller clamp
- Flow regulator
- Needle free valve
- Male luer lock



# BQ+ High Flow Precision Filter

## 大流量精密过滤器

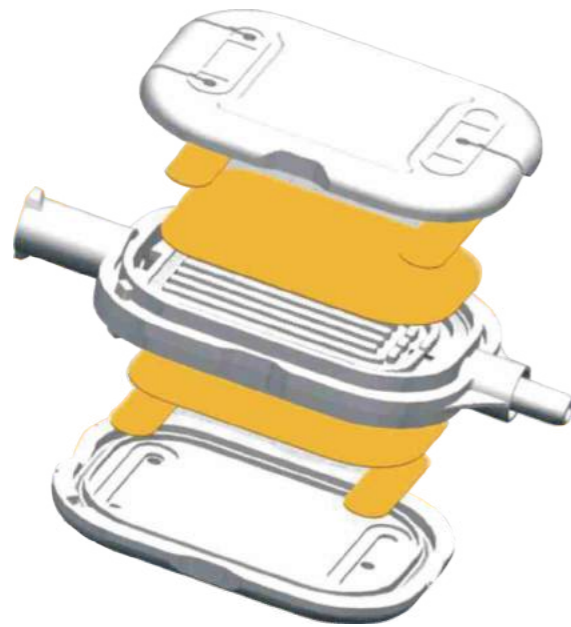

- Features:**
- No leakage under 300Kpa 15S
  - High flow / fast priming available
  - Remove bubble
- Material:**
- ABS body
  - PES membrane
  - PTFE membrane



Description	Color	Aperture	Filter efficiency	Minimum flow reate	Inlet & outlet	Effective filtration area
Adult Square filter High flow sery Air-Vented	Clear /Amber	0.2um	Sterilizing-grade	>320mL/10min	2.9*4.05mm Tubing IN/OUT FLL IN/RMLL OUT	12 cm <sup>2</sup>
		1.2um	≥90%	>1000mL/10min		
		5um	≥90%	>1000mL/10min		
Kid Square filter Air-Vented	Clear /Amber	0.2um	Sterilizing-grade	>150mL/10min	2.9*4.05mm Tubing IN/OUT FLL IN/RMLL OUT	6 cm <sup>2</sup>
		1.2um	≥90%	>900mL/10min		
		5um	≥90%	>1000mL/10min		
Baby Droplet filter Air-Vented	Clear /Amber	0.2um	Sterilizing-grade	>40mL/10min	1.5*3.0mm Tubing IN/OUT FLL IN/RMLL OUT	1.5 cm <sup>2</sup>
		1.2um	≥90%	>300mL/10min		
		5um	≥90%	>550mL/10min		

# Finished IV Set with High Flow Precision Filter

## 成品输液套装—带大流量精密过滤器



### Extension Set

- Extension set for infusion of drugs and liquids
- Female luer lock
  - Precision filter 0.22/1.2/5um(optional)
  - Male luer lock
  - Tubing Length: 15/30/60/90/120cm



### Gravity IV Set

- Standard IV set for infusion of drugs and liquids
- Drop chamber, 20 drops/ml, filter 15um
  - Roller clamp
  - Precision filter 0.22/1.2/5um(optional)
  - Male luer lock



### Pump IV Set

- Pump IV set for infusion of drugs and liquids
- Drop chamber, 20 drops/ml, filter 15um
  - Roller clamp
  - Precision filter 0.22/1.2/5um(optional)
  - Needle free valve
  - Male luer lock



### IV Burette Set

- IV set for Burette set
- Vented spike
  - Roller clamp
  - 100/150ml Burette chamber(optional)
  - Roller clamp
  - Precision filter 0.22/1.2/5um(optional)
  - Needle free valve
  - Male luer lock

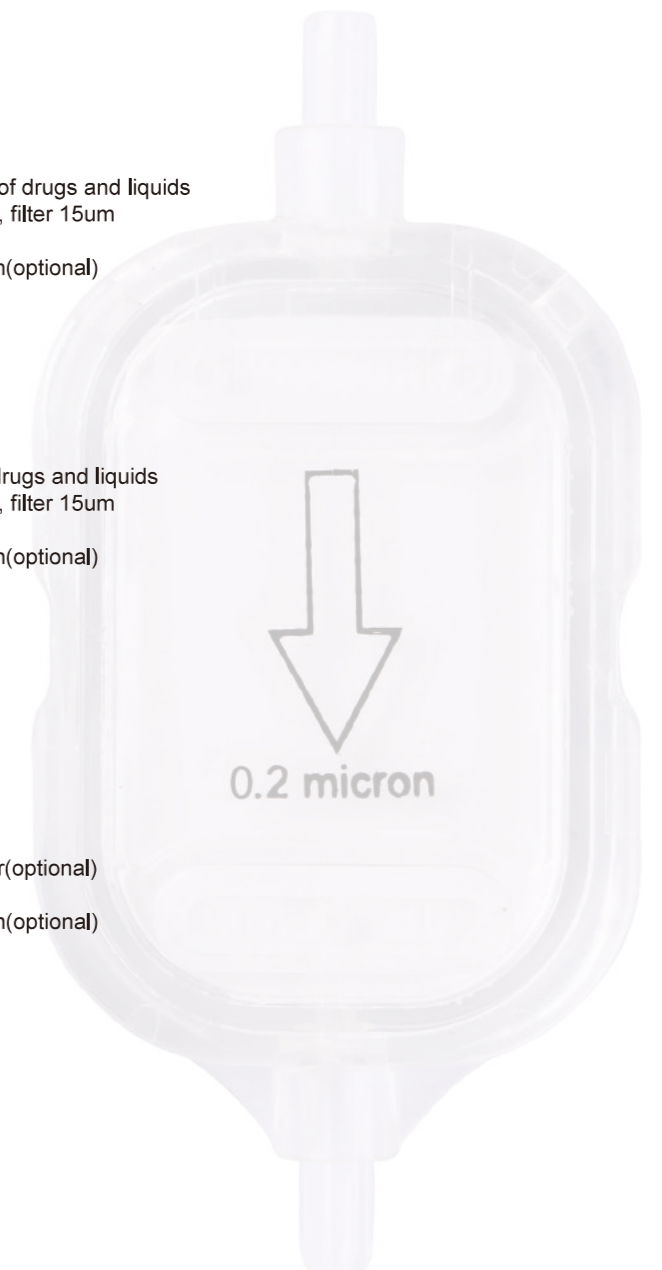



# IV Burette Set 小儿吊瓶套装

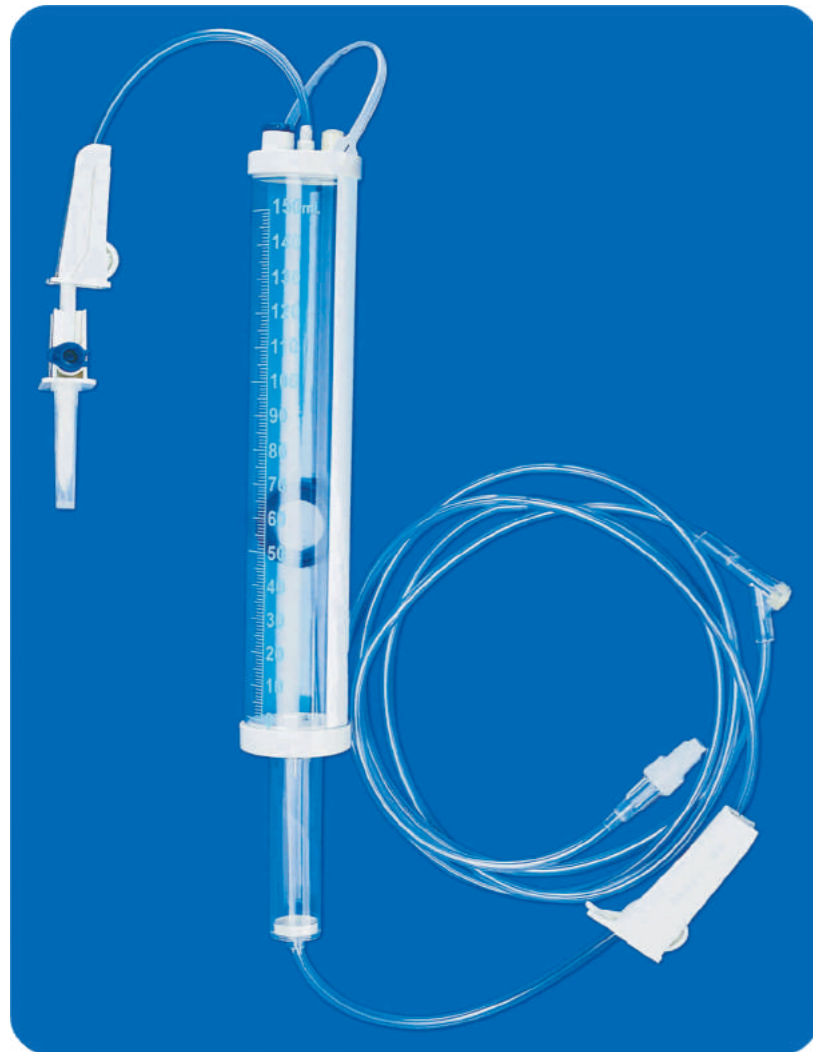

**IV Burette set**  
标准滴定管输液器  
DEHP-Free available

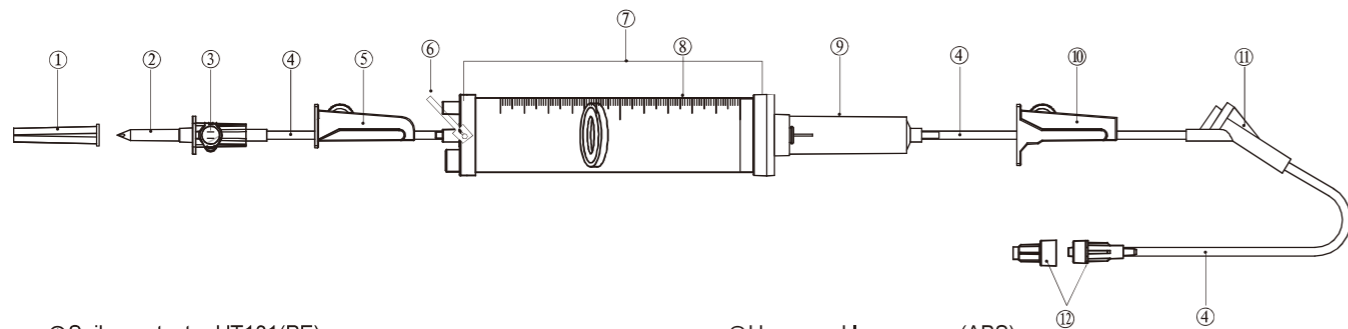

- ① Spike protector HT101(PE)
- ② Vented spike VST01(ABS)
- ③ Air cap(PVC) Hydrophobic membrane 0.5µm(Glass fiber)
- ④ Tube 3.0\*4.0mm(PVC)
- ⑤ ON/OFF Roller clamp RC103(ABS)
- ⑥ Hanger(PE)

- ⑦ Upper and lower cover(ABS)
- ⑧ Burette chamber(PETG)
- ⑨ 72mm Drip chamber(PVC)
- ⑩ Roller clamp RC101-B(ABS)
- ⑪ Y-injection site ST102-IR(PC&Isoprene rubber)
- ⑫ Male luer lock(ABS) and cap(PE)

# Optional Part 可选择的部件

## Upper cover

上盖



Upper Cover	Injection site
	Normal injection site
	with Needle-free valve

## Float Valve

浮阀

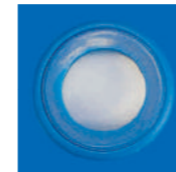

Float Valve	Color	Material
	Blue	PP+Silicon

## Burette Chamber

筒体

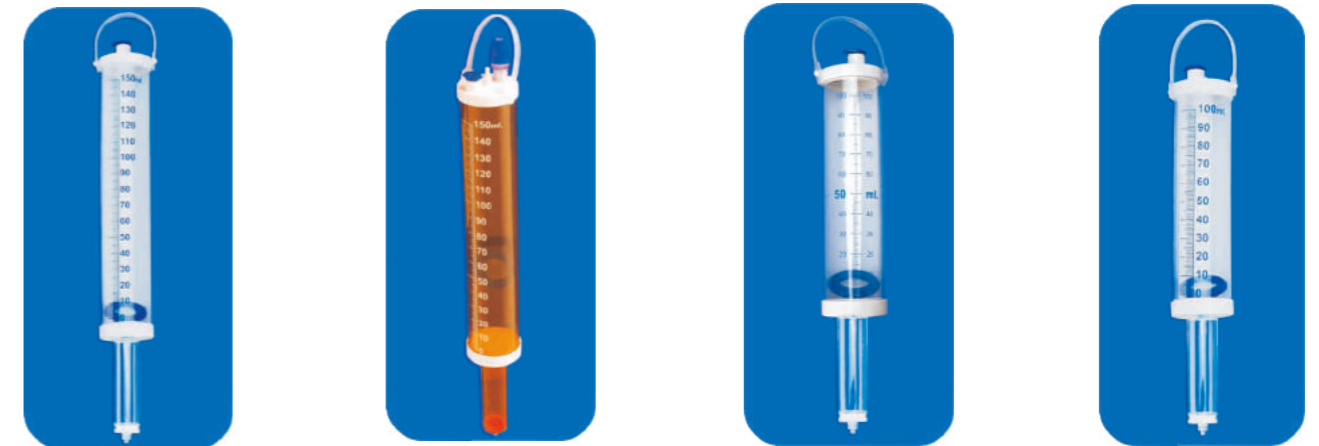

Burette Chamber	Color	Printing	Volume
	Transparent	Single-scale	100 ml
	Light-resistant	Double-scale	150 ml

# Blood Transfusion Set 输血器套装

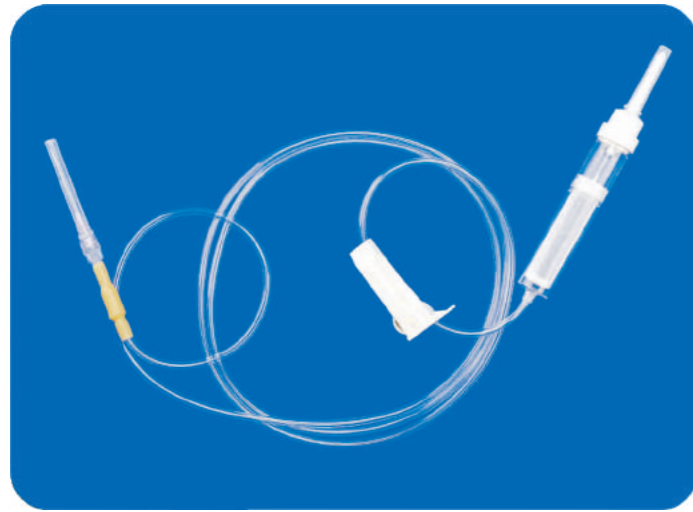

**Blood Set**  
普通输血器

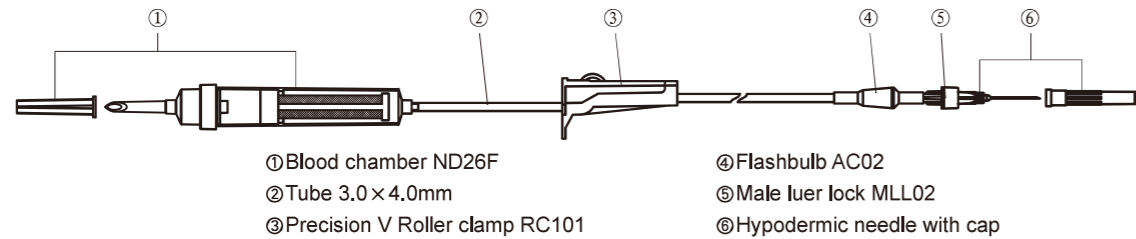

## Air-vented Blood Set

带空气塞输血器

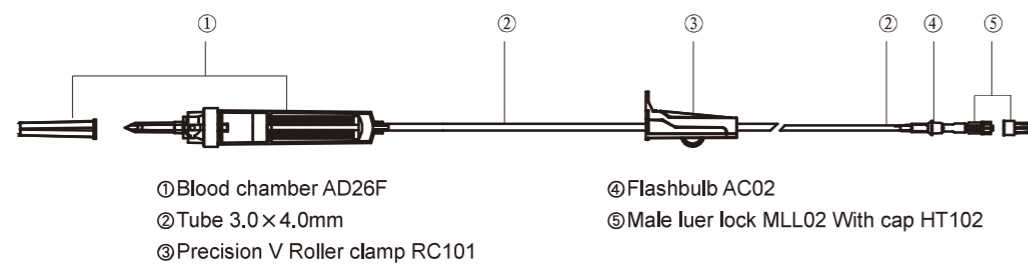

# High Pressure Extension Set 高压延长管

## High Pressure Tubing

高压延长管

- Multiple Length And Connector Types For Choice
- PU Tubing With Nylon Liner For 1200psi
- PVC Tubing For 500psi



Female-Rotaing Adapter



Female-Male Luer Lock



3-Way Stopcock-Male Luer Lock

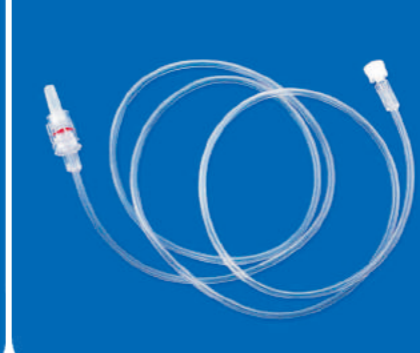

Ret.No.	Type	Product Description	Ret.No.	Type	Product Description
HPEXT101	30cm	Female-Male Luer Lock No Leakage Under 500psi Pressure	HPEXT501	30cm	Rotaing Adapter No Leakage Under 1200psi Pressure
HPEXT102	60cm		HPEXT502	60cm	
HPEXT103	90cm		HPEXT503	90cm	
HPEXT104	120cm		HPEXT504	120cm	
HPEXT105	150cm		HPEXT505	150cm	
HPEXT106	180cm				
HPEXT301	30cm	Female-Male Luer Lock No Leakage Under 1200psi Pressure	HPEXT201	30cm	3-Way Stopcock-Male Luer Lock No Leakage Under 40psi Pressure
HPEXT302	60cm		HPEXT202	60cm	
HPEXT303	90cm		HPEXT203	90cm	
HPEXT304	120cm		HPEXT204	120cm	



## Needle Free Valve Extension Line With Back Check Valve

带无针加药口和单向阀延长管

- Safer Than Heparin Cap With Needle Free Valve
- Prevent Backward Fluid Of Blood
- No Leakage Under 300kPa
- Latex Free

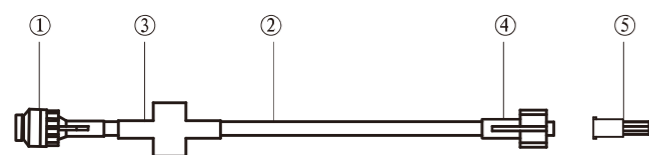

- ① Needle free valve NFV01
- ② PVC Tube
- ③ Back check valve BCV02
- ④ Male luer lock
- ⑤ Cap



Ref.No.	Tub Size (I.D.xO.D.)
EXTNFBC101	1-Way 1.3x2.3

## Extension Line With Needle Free Valve

带无针加药口延长管

- Safer Than Heparin Cap With Needle Free Valve
- No Leakage Under 300kPa
- Latex Free

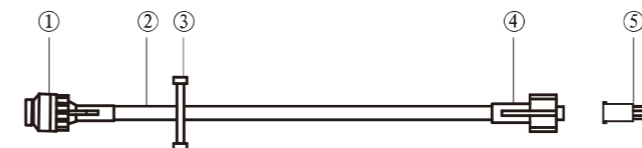

- ① Needle free valve NFV02 or NFV05
- ② PVC Tube
- ③ Slide clamp
- ④ Male luer lock
- ⑤ Cap



Ref.No.	Tub Size (I.D.xO.D.)
EXTNF101	1-Way 1.3x2.3
EXTNF102	1-Way 3.0x4.0

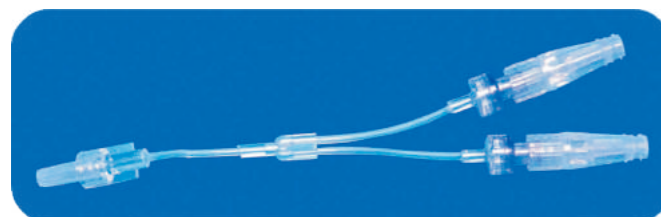

Ref.No.	Tub Size (I.D.xO.D.)
EXTNFBC201	2-Ways 1.3x2.3

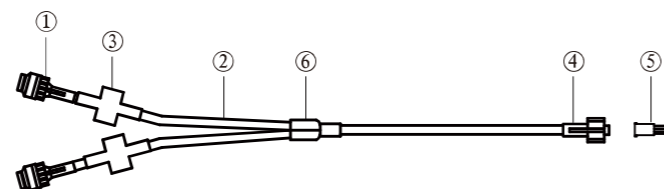

- ① Needle free valve NFV01
- ② PVC Tube
- ③ Back check valve BCV02
- ④ Male luer lock
- ⑤ Cap
- ⑥ Connector



Ref.No.	Tub Size (I.D.xO.D.)
EXTNF201	2-Ways 1.3x2.3
EXTNF202	2-Ways 3.0x4.0

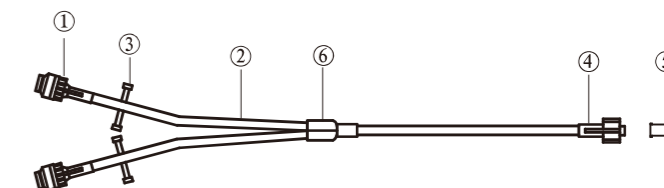

- ① Needle free valve NFV02 or NFV05
- ② PVC Tube
- ③ Slide clamp
- ④ Male luer lock
- ⑤ Cap
- ⑥ Connector

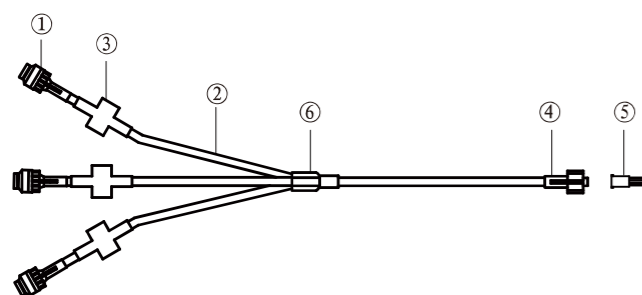

- ① Needle free valve NFV01
- ② PVC Tube
- ③ Back check valve BCV02
- ④ Male luer lock
- ⑤ Cap
- ⑥ Connector

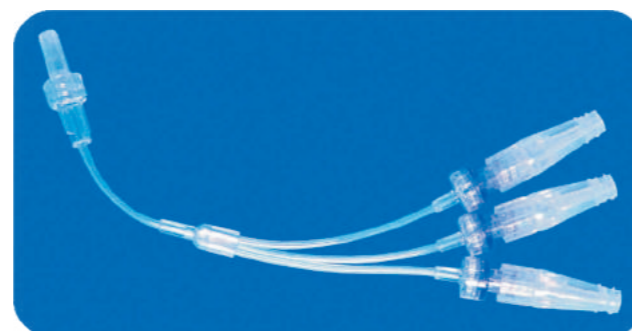

Ref.No.	Tub Size (I.D.xO.D.)
EXTNFBC301	3-Ways 1.3x2.3

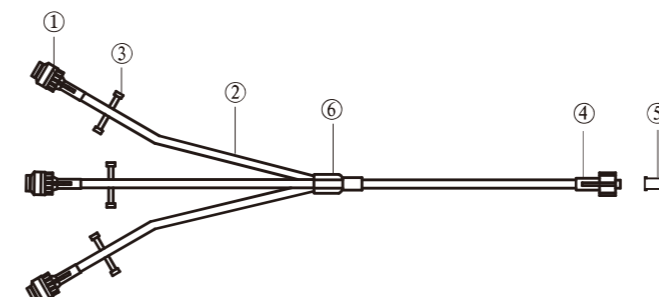

- ① Needle free valve NFV02 or NFV05
- ② PVC Tube
- ③ Slide clamp
- ④ Male luer lock
- ⑤ Cap
- ⑥ Connector



Ref.No.	Tub Size (I.D.xO.D.)
EXTNF301	3-Ways 1.3x2.3
EXTNF302	3-Ways 3.0x4.0

## A1

72空气塞无滤网滴瓶头部, 20滴  
72mm, Vented assembled chamber, 20 drop/ml

- Spike protector, 40mm, PE
- Spike, 20 drop/ml, ABS
- Vented air cap VAC01, PVC, Hydrophobic membrane 0.5µm
- Chamber,  $\Phi$  16.3 x 72mm, PVC.



## A1F

72空气塞滤网滴瓶头部, 20滴  
72mm, Vented assembled chamber with filter, 20 drop/ml

- Spike protector, 40mm, PE
- Spike, 20 drop/ml, ABS
- Vented air cap VAC01, PVC, Hydrophobic membrane 0.5µm
- Chamber,  $\Phi$  16.3 x 72mm, PVC.
- Filter, GLS153,  $\Phi$  15.3mm, ABS, Nylon



## A2

72空气塞无滤网滴瓶头部, 60滴  
72mm, Vented assembled chamber, 60 drop/ml

- Spike protector, 40mm, PE
- Spike, 20 drop/ml, ABS
- Vented air cap VAC01, PVC, Hydrophobic membrane 0.5µm
- Chamber,  $\Phi$  16.3 x 72mm, PVC.
- Micro drip, 60drop/ml, ABS, S.Steel



## A2F

72空气塞滤网滴瓶头部, 60滴  
72mm, Vented assembled chamber with filter, 60 drop/ml

- Spike protector, 40mm, PE
- Spike, 20 drop/ml, ABS
- Vented air cap VAC01, PVC, Hydrophobic membrane 0.5µm
- Chamber,  $\Phi$  16.3 x 72mm, PVC.
- Micro drip, 60drop/ml, ABS, S.Steel
- Filter, GLS153,  $\Phi$  15.3mm, ABS, Nylon



## A3

64空气塞无滤网滴瓶头部, 20滴  
64mm, Vented assembled chamber, 20 drop/ml

- Spike protector, 40mm, PE
- Spike, 20 drop/ml, ABS
- Vented air cap VAC02, PVC, Hydrophobic membrane 0.5µm
- Chamber,  $\Phi$  15.5 x 64mm, PVC.



## A3F

64空气塞滤网滴瓶头部, 20滴  
64mm, Vented assembled chamber with filter, 20 drop/ml

- Spike protector, 40mm, PE
- Spike, 20 drop/ml, ABS
- Vented air cap VAC02, PVC, Hydrophobic membrane 0.5µm
- Chamber,  $\Phi$  15.5 x 64mm, PVC.
- Filter, GLS142,  $\Phi$  14.2mm, ABS, Nylon



## A4

64空气塞无滤网滴瓶头部, 60滴  
64mm, Vented assembled chamber, 60 drop/ml

- Spike protector, 40mm, PE
- Spike, 20 drop/ml, ABS
- Vented air cap VAC02, PVC, Hydrophobic membrane 0.5µm
- Chamber,  $\Phi$  15.5 x 64mm, PVC.
- Micro drip, 60drop/ml, ABS, S.Steel



## A4F

64空气塞滤网滴瓶头部, 60滴  
64mm, Vented assembled chamber with filter, 60 drop/ml

- Spike protector, 40mm, PE
- Spike, 20 drop/ml, ABS
- Vented air cap VAC02, PVC, Hydrophobic membrane 0.5µm
- Chamber,  $\Phi$  15.5 x 64mm, PVC.
- Micro drip, 60drop/ml, ABS, S.Steel
- Filter, GLS142,  $\Phi$  14.2mm, ABS, Nylon







## A5

64空气塞无滤网滴瓶头部, 20滴  
64mm, Vented assembled chamber, 20drop/ml

- Spike protector, 40mm, PE
- Spike, 20 drop/ml, ABS
- Vented air cap VAC02, PVC, Hydrophobic membrane 0.5um
- Chamber,  $\Phi$ 15.5x64mm, PVC



## A5F

64空气塞有滤网滴瓶头部, 20滴  
64mm, Vented assembled chamber with filter, 20drop/ml

- Spike protector, 40mm, PE
- Spike, 20 drop/ml, ABS
- Vented air cap VAC02, PVC, Hydrophobic membrane 0.5um
- Chamber,  $\Phi$ 15.5x64mm, PVC
- Filter, GLS142,  $\Phi$ 14.2mm, ABS, Nylon



## A515

64空气塞无滤网滴瓶头部, 15滴  
64mm, Vented assembled chamber, 15drop/ml

- Spike protector, 40mm, PE
- Spike, 20 drop/ml, ABS
- Vented air cap VAC02, PVC, Hydrophobic membrane 0.5um
- Chamber,  $\Phi$ 15.5x64mm, PVC
- 15drop/ml, ABS



## A515F

64空气塞有滤网滴瓶头部, 15滴  
64mm, Vented assembled chamber with filter, 15drop/ml

- Spike protector, 40mm, PE
- Spike, 20 drop/ml, ABS
- Vented air cap VAC02, PVC, Hydrophobic membrane 0.5um
- Chamber,  $\Phi$ 15.5x64mm, PVC
- Filter, GLS142,  $\Phi$ 14.2mm, ABS, Nylon
- 15drop/ml, ABS



## A110

72空气塞无滤网滴瓶头部, 10滴  
72mm, Vented assembled chamber, 10drop/ml

- Spike protector, 40mm, PE
- Spike, 20 drop/ml, ABS
- Vented air cap VAC01, PVC, Hydrophobic membrane 0.5um
- Chamber,  $\Phi$ 16.3x72mm, PVC
- 10drop/ml, ABS



## A110F

72空气塞有滤网滴瓶头部, 10滴  
72mm, Vented assembled chamber with filter, 10drop/ml

- Spike protector, 40mm, PE
- Spike, 20 drop/ml, ABS
- Vented air cap VAC01, PVC, Hydrophobic membrane 0.5um
- Chamber,  $\Phi$ 16.3x72mm, PVC
- Filter, GLS153,  $\Phi$ 15.3mm, ABS, Nylon
- 10drop/ml, ABS



## N110F-OR

72滤网滴瓶头部, 10滴  
72mm, Non-vented assembled chamber, 10drop/ml

- Spike protector, 40mm, PE
- Spike, 20 drop/ml, ABS
- Chamber,  $\Phi$ 16.3x72mm, PVC
- Filter, GLS153,  $\Phi$ 15.3mm, ABS, Nylon
- 10drop/ml, ABS



## N310

64无滤网滴瓶头部, 10滴  
64mm, Non-vented assembled chamber, 10drop/ml

- Spike protector, 40mm, PE
- Spike, 20 drop/ml, ABS
- Chamber,  $\Phi$ 15.5 x 64mm, PVC.
- 10drop/ml, ABS

## N1

72无滤网滴瓶头部, 20滴  
72mm, Non-vented assembled chamber, 20 drop/ml

- Spike protector, 40mm, PE
- Spike, 20 drop/ml, ABS
- Chamber,  $\Phi$ 16.3 x 72mm, PVC.



## N1F

72滤网滴瓶头部, 20滴  
72mm, Non-vented assembled chamber, 20 drop/ml

- Spike protector, 40mm, PE
- Spike, 20 drop/ml, ABS
- Chamber,  $\Phi$ 16.3 x 72mm, PVC.
- Filter, GLS153,  $\Phi$ 15.3mm, ABS, Nylon



## N2

72无滤网滴瓶头部, 60滴  
72mm, Non-vented assembled chamber, 60 drop/ml

- Spike protector, 40mm, PE
- Spike, 20 drop/ml, ABS
- Chamber,  $\Phi$ 16.3 x 72mm, PVC.
- Micro drip, 60drop/ml, ABS, S.Steel



## N2F

72滤网滴瓶头部, 60滴  
72mm, Non-vented assembled chamber, 60 drop/ml

- Spike protector, 40mm, PE
- Spike, 20 drop/ml, ABS
- Chamber,  $\Phi$ 16.3 x 72mm, PVC.
- Micro drip, 60drop/ml, ABS, S.Steel
- Filter, GLS153,  $\Phi$ 15.3mm, ABS, Nylon



## N3

64无滤网滴瓶头部, 20滴  
64mm, Non-vented assembled chamber, 20 drop/ml

- Spike protector, 40mm, PE
- Spike, 20 drop/ml, ABS
- Chamber,  $\Phi$ 15.5 x 64mm, PVC.



## N3F

64滤网滴瓶头部, 20滴  
64mm, Non-vented assembled chamber, 20 drop/ml

- Spike protector, 40mm, PE
- Spike, 20 drop/ml, ABS
- Chamber,  $\Phi$ 15.5 x 64mm, PVC.
- Filter, GLS142,  $\Phi$ 14.2mm, ABS, Nylon



## N4

64无滤网滴瓶头部, 60滴  
64mm, Non-vented assembled chamber, 60 drop/ml

- Spike protector, 40mm, PE
- Spike, 20 drop/ml, ABS
- Chamber,  $\Phi$ 15.5 x 64mm, PVC.
- Micro drip, 60drop/ml, ABS, S.Steel



## N4F

64滤网滴瓶头部, 60滴  
64mm, Non-vented assembled chamber with filter, 60 drop/ml

- Spike protector, 40mm, PE
- Spike, 20 drop/ml, ABS
- Chamber,  $\Phi$ 15.5 x 64mm, PVC.
- Micro drip, 60drop/ml, ABS, S.Steel
- Filter, GLS142,  $\Phi$ 14.2mm, ABS, Nylon





# IV Chamber Transfusion Chamber 输血器滴瓶

## IV Components 配件 Robert Clamp 罗伯特夹

### AD26F

带空气塞输血滴瓶头部20滴  
98mm, vented assembled blood chamber with filter, 20 drop/ml

- Spike protector, 40mm, PE
- Spike, 20drop/ml, ABS
- Vented air cap PVC, Hydrophobic membrane 0.5µm
- Chamber,  $\Phi$ 17.3 x 98mm, PVC
- Blood filter, GLB02,  $\Phi$ 17.3x62mm, 200µm, ABS/PP, Nylon



### ND26F

输血滴瓶头部20滴  
98mm, Non-vented assembled blood chamber with filter, 20 drop/ml

- Spike protector, 40mm, PE
  - Spike, 20drop/ml, ABS
- Chamber,  $\Phi$ 17.3 x 98mm, PVC
- Blood filter, GLB02,  $\Phi$ 17.3x62mm, 200µm, ABS/PP, Nylon

### ND27F

输血滴瓶头部10滴  
98mm, Non-vented assembled blood chamber with filter, 10 drop/ml

- Spike protector, 40mm, PE
- Spike, 10drop/ml, ABS
- Chamber,  $\Phi$ 17.3 x 98mm, PVC
- Blood filter, GLB02,  $\Phi$ 17.3x62mm, 200µm, ABS/PP, Nylon



### AD27F

输血器双滴瓶头部 20滴  
98mm Vented assembled blood chamber with filter+72mm drip chamber without filter

- Spike protector, 40mm, PE
- Spike, 20drop/ml, ABS
- Chamber,  $\Phi$ 17.3x98mm, PVC
- Blood filter, GLB02,  $\Phi$ 17.3x62mm, 200µm, ABS/PP, Nylon
- Chamber,  $\Phi$ 17.3x72mm, PVC



### CW809-1 CB809-1 CR809-1

Large Clamp  
大罗伯特夹

- Color: Red / Blue / White
- Size: For tube OD F 6.8mm
- Material: POM



### CW809-2 CB809-2 CR809-2

Medium Clamp  
中罗伯特夹

- Color: Red / Blue / White
- Size: For tube OD F 5.5mm
- Material: POM



### CW809-3 CB809-3 CR809-3

Small Clamp  
小罗伯特夹

- Color: Red / Blue / White
- Size: For tube OD F 2.5mm
- Material: POM



### C03

夹片  
Slide Clamp

- Fits 2.2mm tubing
- Material: PE



### C01

夹片  
Slide Clamp

- Fits 4.0mm tubing
- Material: PE



### C04

夹片  
Slide Clamp

- Fits 2.2mm tubing
- Material: PE



## Spike & Back Check Valve 塑针&单向阀

### Spike 塑针



#### ST03

双头塑针  
Spike

- Double Ended Transfer Spike
- Material: ABS & PE



#### ST02

塑针  
Spike

- For tubing O.D.4.1mm
- Material: ABS

#### ST18

塑针  
Vented Spike

- For tubing O.D.4.0mm
- Material: ABS

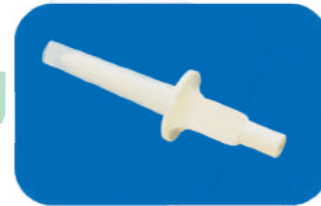

#### VST01

塑针  
Vented Spike

- For tubing O.D.4.0mm
- Material: ABS



## Back Check Valve 单向阀

### BCV

单向阀  
Back Check Valve (One-Way Valve)

- Back Pressure: > 300kPa
- Flow rate: 100ml/min
- Latex Free



Ret.No.	Product Description
BCV06	Female-Male Ends
BCV08	Male-Tube Ends 2.3*3.5mm (I.D.xO.D.)
BCV10	Female-Tube Ends 2.3*3.5mm (I.D.xO.D.)
BCV12	Tube-Tube Ends 2.3*3.5mm (I.D.xO.D.)

## High Pressure Manifold & Stopcock 高压联板&高压三通阀

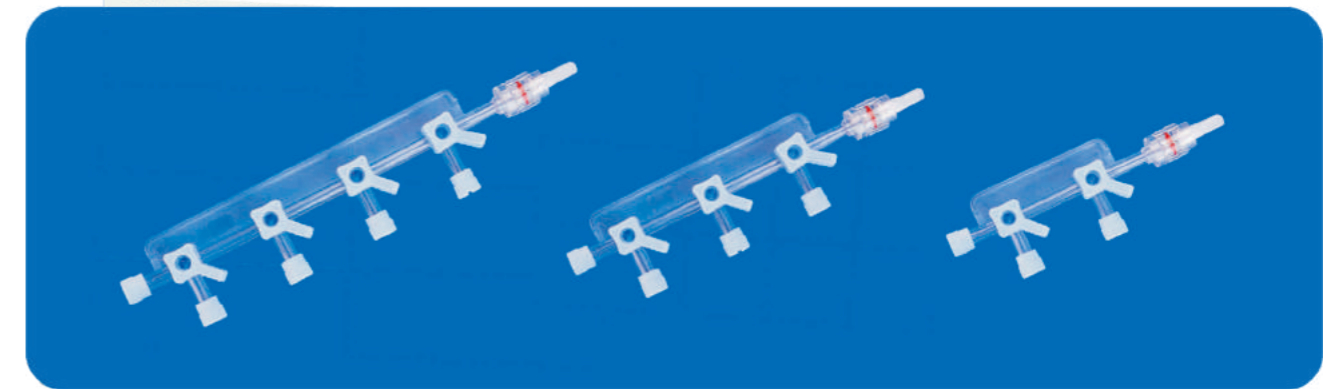

### High Pressure Manifold

高压联板

- No Leakage under 500psi
- Smooth rotation, easy use
- Different color for choice

	Ref.No.	Product Description
2 Ports	HPM201	"ON" type with rotating adapter, Right port orientation
	HPM202	"OFF" type with rotating adapter, Right port orientation
3 Ports	HPM301	"ON" type with rotating adapter, Right port orientation
	HPM302	"OFF" type with rotating adapter, Right port orientation
	HPM303	"ON" type with pressure line, Right port orientation
	HPM307	"ON" type with rotating adapter, left port orientation
	HPM308	"OFF" type with rotating adapter, left port orientation
4 Ports	HPM401	"ON" type with rotating adapter, Right port orientation
	HPM402	"OFF" type with rotating adapter, Right port orientation

### High pressure Stopcock

高压三通阀

- No Leakage under 1000psi Pressure
- Different color for choice
- Smooth rotation, easy use

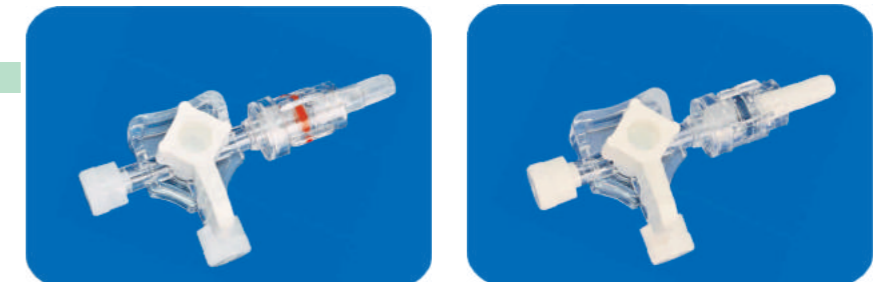

Ref.No.	Product Description
HPSK0106	"ON" Type, Rotating Adapter, No Leakage under 1000psi Pressure
HPSK0108	"ON" Type, Rotating Adapter, No Leakage under 500psi Pressure
HPSK0109	"OFF" Type, Rotating Adapter, No Leakage under 1000psi Pressure
HPSK0110	"OFF" Type, Rotating Adapter, No Leakage under 500psi Pressure

## Injection Site 加药件



### ST103-Y

嵌入式三通加药口合成胶  
Y-injection site, latex-free

- Size: length=35mm, with easy handle
- Material: ABS, Isoprene rubber



### ST103-OR

嵌入式三通加药口合成胶  
Y-injection site, latex-free

- Size: length=35mm, with easy handle
- Material: ABS, Isoprene rubber



### ST104-Y

嵌入式三通加药口合成胶  
Y-injection site, latex-free

- Size: length=32.4mm, with easy handle
- Material: PC, Isoprene rubber
- Pre-pierced available



### ST102-IR

嵌入式三通加药口合成胶  
Y-injection site, latex-free

- Size: length=35mm
- Material: ABS, Isoprene rubber



### ST108-IR

嵌入式三通加药口合成胶  
Y-injection site, latex-free

- Size: length=38.9mm
- Material: PC, Isoprene rubber
- Pre-pierced available



### ST113-IR

嵌入式三通加药口合成胶  
Y-injection site, latex-free

- Size: length= 35mm
- Material: ABS, Isoprene rubber

### STY08-IR

透明肝素帽  
Transparent male luer lock injections site

- Heparin cap, latex-free
- Material: ABS, Isoprene rubber



### STY09-IR

八角透明肝素帽  
Transparent male luer lock injections site

- Heparin cap, latex-free
- Material: ABS, Isoprene rubber



### STY07-IR

合成胶肝素帽  
Male luer lock injection site

- Heparin cap, latex-free
- Material: ABS, Isoprene rubber



### STY10-IR

透明肝素帽  
Transparent male luer lock injections site

- Heparin cap, latex-free
- Material: PC, Isoprene rubber
- Pre-pierced available



### STY11-IR

合成胶肝素帽  
Male luer lock injection site

- Heparin cap, latex-free
- Material: PC, Isoprene rubber
- Pre-pierced available



### AC02

乳胶泡合成胶  
Flashback, latex-free

- Size: length=45mm
- Material: Isoprene rubber



## Roller Clamp 滚轮流量调节器

### RC101-B

长尾调节器  
Precision V Roller clamp

- Size: length=56mm
- For tubing O.D.4.0mm
- Material: ABS



RC101-B

### RC102-B

短尾调节器  
Precision V Roller clamp

- Size: length= 56mm
- For tubing O.D.4.0mm
- Material: ABS



RC102-B

### RC103

小调节器  
Precision V Roller clamp

- Size: length= 45mm
- For tubing O.D.4.0mm
- Material: ABS



### RC102-C

短尾调节器  
Precision V Roller clamp

- Size: length=56mm
- For tubing OD 4.0-4.2mm
- Material: ABS



RC102-C

### RC108

止液调节器  
Roller clamp used on air stop infusion set

- Size: length= 56mm
- For tubing O.D.4.0mm
- Material: ABS





## Luer Lock 鲁尔接头



**FLL01**  
母螺旋  
Female Luer Lock

- Size: For tube OD 2.5/3.0/4.0mm
- Material: ABS/PC
- Cap: HT105, PE



**FLL02**  
母螺旋  
Female Luer Lock

- Size: For tube O.D. 3.0/4.0/5.0/5.4mm
- Material: PC/ABS



**FLL05**  
母螺旋  
Female luer lock

- Size: For tubing OD 4.0mm
- Material: PC



**FLL04**  
母螺旋  
Female luer lock

- Size: For Tubing I.D. 4.0/4.7/6.4mm
- Material: PC



**MLL02**  
螺旋座  
Male luer lock

- Size: length=32mm, for flashback
- Material: ABS
- Cap: HT102, PE



**MLL03**  
内外扣管式螺旋座  
Male luer lock

- Size: length=40mm, for tube 3x4.1mm
- Material: ABS
- Cap: HT103, PE



**MLL04**  
公螺旋  
Male Luer Lock for extension

- Size: For tube OD 2.5/3.0/4.0mm
- Material: ABS/PC
- Cap: HT104, PE



**MLL10**  
公螺旋  
Male Luer Lock

- Size: For tubing I.D. 4.0/4.7/6.4mm
- Material: PC



**MLL13**  
公螺旋  
Male luer lock

- Size: For Tubing O.D. 4.0mm
- Material: ABS/PC



**DMC-01**  
混药接头  
Fluid Dispensing Connector

- Female to female ends
- Sterile, blister package



**HT110-2N**  
护帽  
Cap

- Material: PE/PP
- L= 19mm
- Non-vented



**CN01/CN13**  
三通  
Connectors

- Size: For tube O.D. 2.3/4.0mm
- Material: PVC

## Luer Lock 鲁尔接头



**MLL05**  
三联件/可脱卸螺旋座  
Detachable spin luer lock

- Size: for tube OD 4.0mm
- Material: ABS
- Cap: HT106, PE



**MLL05-OR**  
避光三联件/可脱卸螺旋座  
UV Detachable spin luer lock

- Size: for tube OD 4.0mm
- Material: ABS
- Cap: HT106, PE



**MLL05-B**  
三联件/可脱卸螺旋座  
Distachable spin luer lock

- Size: for tube OD 4.0mm
- Material: ABS
- Cap: HT130, PP, blue/green/red  
With hydrophobic membrane 0.2/1.2/3.0µm



**MLL12**  
三联件/可脱卸螺旋座  
Detachable spin luer lock

- Size: for tubing OD 2.0/2.2/2.4/2.5mm
- Material: ABS/PC
- Cap: HT107, PE



**MLL14**  
不可拆卸/可旋转螺旋座  
Undetachable spin luer lock

- Size: for tubing OD 3.6/4.0mm
- Material: PC
- Cap: HT106



**MLL104**  
螺旋座  
Male Luer Lock

- Material: ABS
- For Tube OD 2.9/4.0MM



**MLS01**  
带翅膀三通  
Male luer slip

- Size: length=30mm, for flashback
- Cap: HT107, PE



**MLS02**  
小三通  
Male Luer slip

- L=29mm
- Size: For Flashback
- Cap: HT107, PE



**MLS03**  
三联件三通  
Male Luer slip

- L=28mm
- Size: For tube OD 3.0/4.0 mm
- Cap: HT107, PE

## Cap 护帽



**HT151**  
护帽  
Cap

- Material: ABS
- For stopcock



**HT152**  
护帽  
Cap

- Material: PE
- For stopcock



**HT153**  
带孔护帽  
Cap With Hole

- Material: PP



## 符合人体工学的造型设计 Ergonomic Shape Design

面罩采用了人体工程学的设计，因此只需使用最小的压力即可达到密封，便于医生的单手操作  
The mask is designed according to human engineering, then it only needs smallest pressure and then reaches a seal over the face. The doctor can operate it by single hand



## 无毒无味的环保材料 Safe & Green Material

面罩的主要材料采用PP和TPE等医用级原料，不含PVC，不含乳胶，不但可以保护病人的安全，同时对环境无影响  
BQ+ Musk is made of Medical Grade PP & TPE, contain no PVC or Latex, it will protect patient's safety and also the environment



## 容易识别的尺寸选择 Rememberable Size Choices

面罩仅有4个型号，却涵盖了所有年龄阶段的病人的使用。不但方便医生的选择，而且可以减轻库存管理  
The mask has only 4 sizes but covers all patients' treatment. It is not only convenient for doctor's choice, but also good for stock management.

Mask 面罩型号	Patient	适用病人
Mask Papa	Male adult	成年男性
Mask Mama	Female adult	成年女性
Mask BQ	Kid	小孩
Mask BB	Baby	婴儿

## 美容注射器

Aesthetic Syringe 一次性医学美容深度可调注射器，专利号：ZL201510612757.0

妙手仁心，创造真善美

The curer benevolent heart creates true, love and beauty.

鲨鱼尾助推器：  
注射粘稠液体更加省力

Shark tail-shaped Shark booster:  
Facilitate the injection of viscous liquid.

32G超细短斜面针尖，  
无痛无出血

32G ultra-thin & short bevel cannula brings you no pain or bleeding

Item No.	Gauge	Length
1G3207	32G	7mm
1G3210	32G	10mm
1G3213	32G	13mm



回抽拇指环：接近血管或神经时迅速回抽

Withdrawing thumb loop: Allow immediate withdrawing in the case of approaching to blood vessels or nerves.

## 注射美容混药接头

Disposable Solid Connector for Luer Lock & Luer Slip

将两个注射器的鲁尔公接头进行对接，用于药品及其他液态物质的混合、分配和转移。

The docking of male Luer connectors of two syringes can realize mixing, distribution and transfer of drugs and other liquid substances.

还可用于美容注射时，注射器的暂时搁置。

The apparatus can also used for temporary syringe holding during cosmetic injection.



Item No. : DFL05



# About US 公司简介

Established in 2015, BQ+ Medical is a professional manufacturer of Medical Disposable Devices, a member of China Association for Medical Devices Industry.

BQ+ Medical not only produce components for manufacturers all over the world, but also provide private label manufacturing for leading brand distributors in different countries.

上海必趣医疗科技有限公司成立于2015年，是医疗一次性设备的专业制造商，是中国医疗器械行业协会的成员。

上海必趣医疗科技有限公司不仅为世界各地的制造商生产零件，而且还为不同国家的领先品牌经销商提供自有品牌的制造。



BQ+ Medical has 9900+ Sqm production facility, including 3360sqm Class 8 Clean Room. BQ+ Medical is FDA registered, ISO 13485 certified, CFDA Class II production licensed manufacturer. BQ+ Medical provide ETO sterilization service, which is also FDA registered, ISO 11135 certified.

BQ+ Medical product range covers infusion & Blood transfusion sets, Enteral feeding bags & sets, Anesthesia masks, Aesthetic syringe and connectors, pharmacy compounding preparation devices and also intervention accessories.

80% BQ+ Medical customers are from abroad, product quality, documentation & traceability, and on time delivery are the 3 key concerns for medical supply companies. BQ+ Medical invests huge resource on quality system. Former TUV Sud Auditor, Mr. Jack Yang acts as Management Representative for BQ+. BQ+ Medical hires TOC expert coaching our team to improve work flow to agile manufacturing. BQ+ Medical is also working MES system to achieve paperless traceability. Located in Shanghai, makes it convenient for overseas customers to visit BQ+, high qualified team and strong supply chain promises excellent quality and sufficient productivity.

Once you get in touch with BQ+ team, you will be impressed by the sincerity, Integrity and diligent of BQ+ people. Welcome to BQ+ Medical, please feel free to contact us anytime!

上海必趣医疗科技有限公司拥有9900平米的生产设施，包括3360平米的8级无尘室。必趣医疗是FDA注册，ISO13485认证，CFDA II类生产许可的制造商。必趣提供ETO灭菌服务，该服务也已获得FDA注册，ISO11135认证。

上海必趣医疗科技有限公司产品范围包括输液和输血套件，肠内输液袋和套件，麻醉口罩，美容注射器和连接器，药物混合制备设备以及介入配件。

上海必趣医疗科技有限公司80%的客户来自国外，产品质量，文档和可追溯性以及准时交货是医疗供应公司的三个主要关注点。必趣医疗在质量体系上投入了大量资源。TUV前资深审核员，Jack Yang先生担任必趣的管理代表。必趣医疗聘请TOC专家指导我们的团队，以改善敏捷制造的工作流程。必趣也正在使用MES系统以实现无纸化可追溯性。

高素质的团队和强大的供应链位于上海，方便客户访问必趣，保证了卓越的品质和足够的生产力。一旦与必趣团队取得联系，您就会对BQ+员工的真诚，正直和勤奋印象深刻。

欢迎来访必趣医疗，欢迎与我们联系！



ENISO13485:2016: SX601277200001



CE certificate: DD601402690001



FDA listed for Ethylene Oxide Sterilize service, Manufacturer IV extension set, IV infusion set Anesthetic Mask, Liquid Medication Dispenser



KFDA Certificate of GMP for syringe or needle,



ANVISA register ID for Anesthesia Face Masks: 81304790055

## WHY BQ+

408

Components made in house

28

Containers capacity per month

95%

On time delivery

100%

Traceability guaranteed

## SOLUTIONS



Standard Components

Hundreds of items for quick delivery



Customized Assembly

For sets sterilized with your brand



OEM CONTRACT Manufacturing

To produce according to your drawing

## R&D DEPARTMENT 研发团队



R&D department is originated from technology section. Now this new department is focus more and more on R&D. Though we are young, we are dynamic and committed to transforming customers' ideas into products that can be produced stably in batches. Under our mutual efforts, we start from an idea, to 3D modeling, to drawings, to model construction, to samples, to tests, to verification, to production process implementation. Each project is connected with 5-10 technicians from sales to quality, procurement, production site and etc. The whole process of project management is under well took. We have different engineer for different product, in general, one main engineer for one project and he can invite other engineer to responsible for small part of the project. We have formed a trust, Efficiency and well-orchestrated team.



Department director Mr. Eddie Zhang is specialized in mold design & manufacture. He works 17 years in product design field and developed many products. R & D engineers have 6 years working experience at least. One of our process engineer has been working in process technology and process improvement for 14 years, and another verification engineer has been working for more than 10 years in verification area. As a result, many patents have been granted. BQ holds 13 patents and 2 of them are invention patents. Still more patents are in applying.





BQ+ has 408 components, based on these components we can assemble finished products, semi-finished products, tubes, components for manufacturers and distributors all over the world. We can also customized products for customers.



26 products have acquired CE certificate. 2 products have finished the register with CFDA. We are also doing the register with FDA to acquire 510K for some of our products now.



We also focus on Industry-University-Research Cooperation. We cooperate with universities and hospitals for different products. BQ+ is the doctoral internship base of Donghua University. We have a nano electrostatic spinning technology application laboratory of Donghua University. BQ+ and Donghua University study intelligent chronic wound dressing together with clinical experts of Ruijin Hospital. 2 invention patents have been obtained. It is expected that the world's leading products will be approved and put into clinical application in 2023.

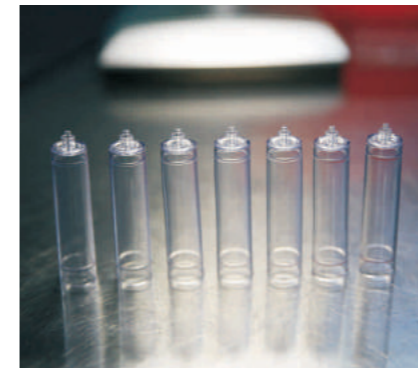

BQ+ engineers have more than 17 years experience on molding transparent medical parts  
必趣医疗工程师在模塑透明医疗配件方面拥有超过17年的经验。

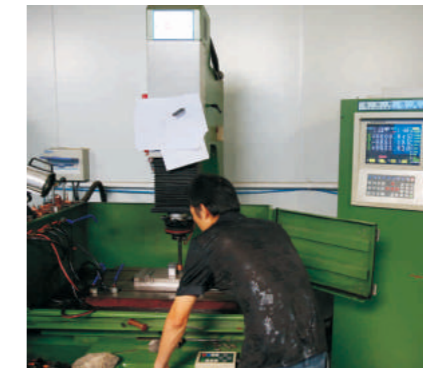

BQ+ has in house mold repairing and maintenance  
必趣医疗拥有自主模具维修和保养团队。

## PRECISE EXTRUSION 精密挤出

合格的输液管要求始终一致的内径和外径控制。



BQ+ has 5 extrusion lines, including high speed extrusion, co-extrusion machines. 必趣拥有5条挤出生产线, 其中包括高速挤出, 共挤出机。

## 注塑模塑

# INJECTION MOLDING

BQ+ Production Division is very strong at injection molding  
必趣医疗生产部在注射模塑方面非常强大。



BQ+ has 32 injection molding machines, range from 100 ton to 220 ton.  
必趣医疗拥有32台注塑机, 范围从100吨到220吨。



JSW High speed molding press injection speed reach 500mm/s  
JSW高速模压机的注射速度达到500mm/s。



2-Color injection machines can mold two material at same time on 1 part  
2色注塑机可以在1个零件上同时模制两种材料。



Mold cooling system promise high efficiency.  
模具冷却系统保证高效率。



BQ+ injection molding has excellent stability.  
必趣医疗注射模塑具有出色的稳定性。



Minimum residual in screw is lower than 0.1mm, which assure precise dimension and perfect appearance.  
螺丝中的最小残留物小于0.1mm, 从而确保了精确的尺寸和完美的外观。



12 meter water tank to assure fast cooling  
Screw speed:  $\pm 0.03\text{rpm}$  Pulling speed:  $\pm 0.05\text{m/min}$   
12米水箱, 确保快速冷却  
螺杆转速:  $\pm 0.03\text{rpm}$  牵引速度:  $\pm 0.05\text{m/min}$



Siemens PLC  
西门子PLC



In line OD controlling: Tube OD:  $\pm 0.03\text{mm}$   
Wall thickness:  $\pm 0.01\text{mm}$   
在线外径控制:  
管子外径:  $\pm 0.03\text{mm}$   
壁厚:  $\pm 0.01\text{mm}$



In line OD controlling:  
Test per 1 sec.  
线上外径控制:  
每一秒测一次



Co-extrusion machines could produce two material tubing  
共挤机可以生产两种物料的管子。



In line OD controlling: Automatic feedback for Synchronized adjustment  
线上外径控制: 自动反馈, 同步调整



## AUTOMATIC ASSEMBLING 自动组装



6 parts drip chamber assembly  
6个零件滴液室组件。



Roller clamp assembly  
滚轮调节器组装。



Spin luer lock assembly  
旋转鲁尔组装。



Enplus spike assembly  
喂食塑料针组装。

## 手动组装

## MANUAL ASSEMBLING

BQ+ has 100+ experienced operators doing various assembling jobs  
BQ+有100多名经验丰富的操作员从事各种组装工作。



UV Curing Machines  
紫外线固化机



Ultrasonic Welding  
超声波焊接



Heat welding  
热焊接

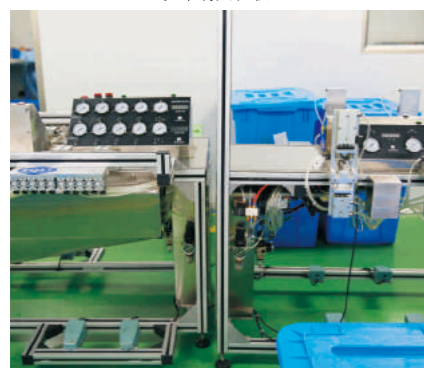

Leakage testing  
泄漏测试



Hot stamping  
烫金



Screen printing  
丝网印刷

## PACKAGING 包装



Soft blister packing machine  
软吸塑包装机



Hard Blister packing machine  
硬吸塑包装机



Manual packing  
封口机

## EO 灭菌中心 STERILIZATION

ISO11135 certified/FDA registered  
1 pre-heating of 100cubic meter  
3 sterilizers of 20 cubic meters  
2 sterilizers of 6 cubic meters  
1 Aeration of 20 cubic meters



ISO11135认证/FDA注册  
1台预热100立方米  
3台20立方米的灭菌器  
2个6立方米的消毒器  
1充气20立方米



Provide sterilization services  
提供EO灭菌服务

## Please Contact Us

Charles Zou 邹李文广 Sales Manager  
charles@bq-medical.com  
+86-18407821655  
Asian, North American market



Vincent Yuan 袁绪俊 Sales Manager  
vincent@bq-medical.com  
+86-18217001268  
Australia, Middle East market



Grace Gao 高雅 Sales Manager  
Grace@bq-medical.com  
+86-13918755351  
European, Korean market



Jenny Liu 刘静 Sales Manager  
Jenny@bq-medical.com  
+86-15710106844  
South American market